

DESCRIPTION

- Brass swivel ball assembly

OPERATION

- One function, rain
- For best performance, mount rainshower directly overhead

FLOW

- Showerhead limited to 2.5 gpm (9.5 L/min) MAX at 80 psi
- EP suffix models are limited to 1.75 gpm (6.7 L/min) MAX at 80 psi

STANDARDS

- Third party certified to meet ASME A112.18.1/ CSA B125.1 and all applicable requirements referenced therein
- EP suffix models are third party certified to WaterSense®

WARRANTY

- Lifetime limited warranty against leaks, drips and finish defects to the original homeowner
- 10 year limited warranty when used in a multifamily installation
- 5 year limited warranty when used in a commercial installation

Visit www.moen.com/support for complete details and limitations

IMPORTANT CLEANING & CARE INSTRUCTIONS:

Moen recommends cleaning this rainshower with a mild soap, rinsing thoroughly with warm water and drying with a clean, soft cloth. Never use cleaners containing abrasives *including abrasive sponges or steel wool), ammonia, bleach or sodium hypochlorite, organic solvents (e.e. alcohols) or other harsh chemicals (e.g. lime scale removers) to clean the finish, as they may damage the finish. Failure to comply with these cleaning instruction may void Moen's warranty.

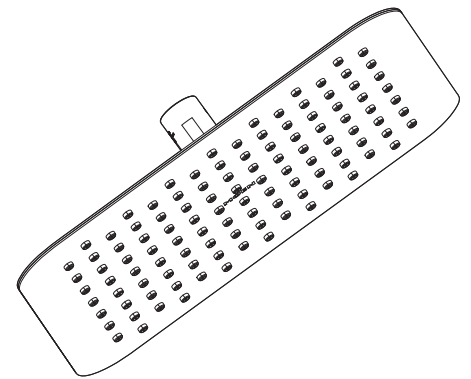

10" One Function Overhead Mount Rainshower

Models: S1003 series

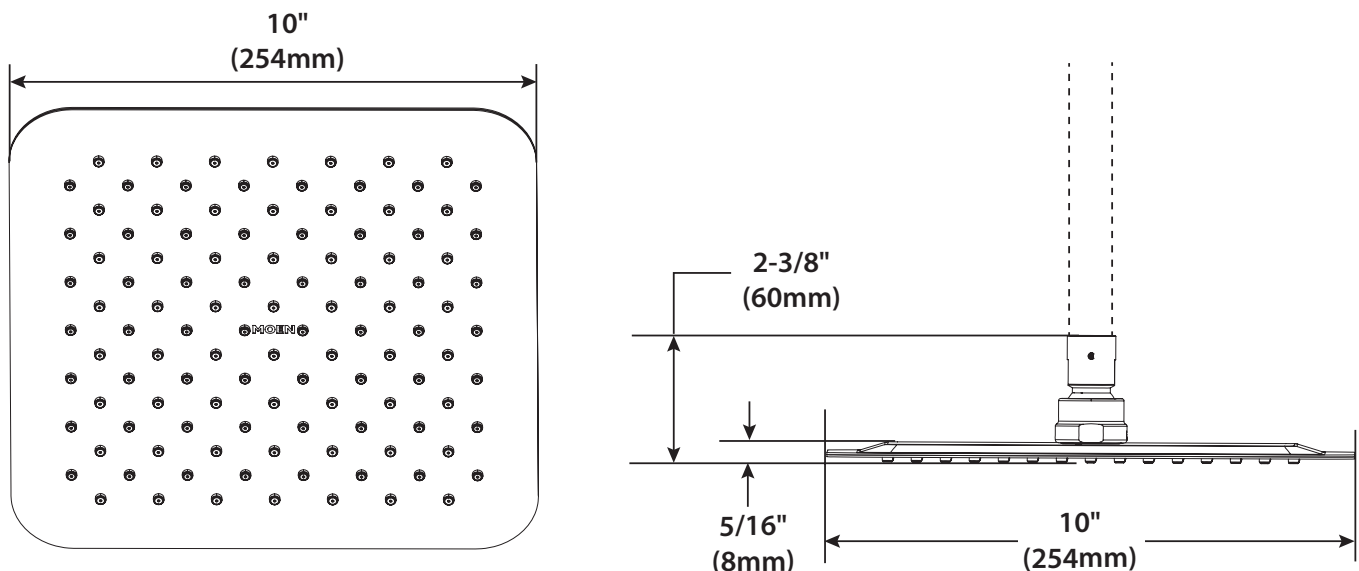

CRITICAL DIMENSIONS

(DO NOT SCALE)